

52.500

Addit monitor stand 500

A great, easy and affordable way to get more out of the monitor. Replace your default stand that came with the monitor with this solid steel monitor stand and you can now adjust your monitor in height, tilt and even rotate it, to switch between portrait and landscape mode.

- Suitable for 1 monitor up to 15 kg (33 lb)
- VESA MIS-D 75 x 75/100 x 100 mm compatible
- Footprint 250 x 202 mm (9,8 x 8,0")
- Made of steel
- Height adjustable 240 - 385 mm (9,4" - 15,2")
- Monitor: tilt +55°/-55°, rotate 360°
- Raises a monitor up to 100 mm (3,9") higher than most monitor stands

addit

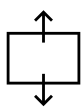
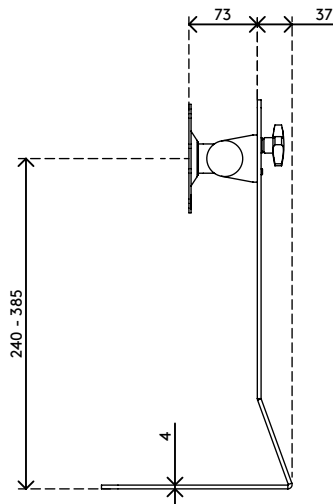
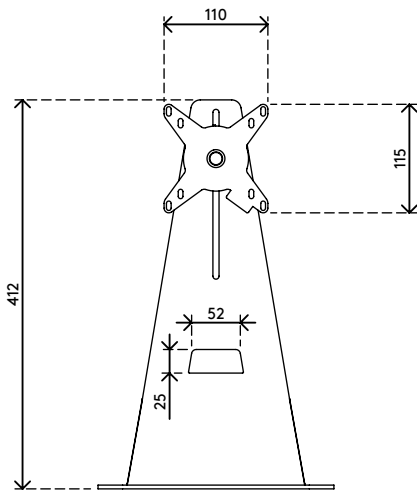
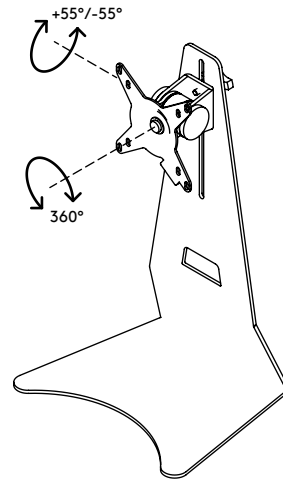
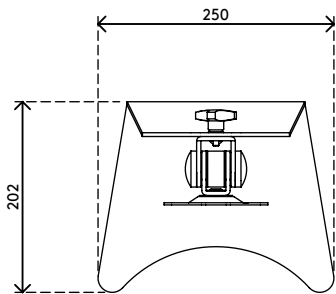

145 mm (5,7")



+55°/-55°



360°



770 mm (30,3")



75 x 75/100 x 100



15 kg (33 lb)

Addit monitor stand 500

2020/10/06

52.500

 265 x 230 x 475 mm

 1 pcs

 white

 3,73 kg

 805410525002